

Client: _____ Project Name: _____

MODA Contact: _____ E-Mail: _____

SKU: _____ Type: _____ PO#: _____ Quantity: _____

Notes: _____



Specification Grade Premium Interior Graze Fixture.

MODA GRAZE Interior is a patent pending wall grazing lighting system designed for interior applications. Utilizing MODA's latest software and dimming technology with its onboard dimming chipset and MODA firmware, this series can dim to 0% smoothly without any flicker or noise and simultaneously synchronize dim with every fixture. Electronic Low Voltage dimming has no minimum run lengths. With MODA's methods of precision and high standards of work, MODA achieves perfect illumination. Color Rendering Index is at a MODA standard of 94-98. R1 - R15 values are in excess of 90. No striations, no color over angle, and no dark spots.

Small in physical size, yet powerful with up to 1200 lm/ft. Wall wash any applications with a choice of 6°, 10°, 25°, 40°, 10°x40°, 30°x60°, or forward throw asymmetric beam patterns for SO+ and HO, or 30°x100° for LO, SO or HO+ Lumen packages. Standard color temperatures available are 2200K, 2700K, 3000K, 3500K, 4000K, 5000K. Other CCT are available by request. 100-277V, 50/60Hz power input allows these fixtures to be installed anywhere in the world. New patent pending locking bracket rotates 180° for a multitude of light directions. Rugged aluminum design. Protected from corrosion and harsh weather conditions by MODA GUARD—a tough seal which protects the fixture. Fast installation is achieved with MODA KWIK CONNECT plugs and install-integral thumb latch connectors. Choice of five lumen packages ranging from 300 lm/ft to 1200 lm/ft. Available in 1ft & 4ft sections. Series is designed for driver or light engine to be factory replaced at its end of life or recycled.

Designed and developed in Las Vegas, USA by MODA

PAGE

3 FEATURES

4 1 FOOT

5 4 FOOT

6 OPTIC FLEXIBILITY

7 OPTIC FLEXIBILITY

8 TM30

9 TM30

10 ELV WIRING

11 0-10V TO ELV

12 ACCESSORIES: CABLES

13 FIXTURES AND ACCESSORIES

PHYSICAL

Dimensions	L: 12 3/8in (316mm) W: 2 7/16in (61mm) L: 47 5/16in (1202mm) H: 2 3/8in (60mm)
Weight	12in: 1lbs (0.45kg) 48in: 3.3lbs (1.5kg)
Applications	Graze, Accent, & Indirect General Illumination
Construction	Pure Aluminum Body, Polycarbonate Mounting Bracket and Polycarbonate Optical Lens
Ingress Protection	Dry/Damp IP44
Thermal Management	Moda Aluminum Heat Sink
Fixture Connections	Integral Male & Female Connectors
Operating Temperature	-40°F ~ 122°F (-40°C ~ 50°C)
Storage Temperature	-40°F ~ 176°F (-40°C ~ 80°C)
Humidity	0-95% Non Condensing

SPECIFICATIONS

	Lumens		Efficacy	
	1FT	4FT	1FT	4FT
LO	225 - 316	901 - 1264	22 - 32	22 - 32
SO	306 - 444	1231 - 1768	31 - 44	31 - 44
SO+	752 - 1032	2552 - 3439	75 - 103	64 - 86
HO	1190 - 1490	3567 - 5243	119 - 149	89 - 131
HO+	976 - 1115	3868 - 4461	98 - 112	97 - 112

POWER CONSUMPTION

	120V - 277V AC	
	1FT	4FT
LO	4W	16W
SO	5W	19W
SO+	10W	40W
HO	10W	40W
HO+	10W	40W

OUTPUT

Colors	2200K*, 2700K, 3000K, 3500K, 4000K
Beam Angle	6°, 10°, 25°, 40°, 10°x40°, 30°x60°, Forward Throw Asymmetric, or 30°x100° optic options
CRI	94-97
SDCM	2-Step MacAdam Ellipse
Color Bin Tolerance	Single Bin
Lumen Maintenance	90,000 Hours L70 @ 25°C 70,000 Hours L70 @ 50°C
Testing Data	Light Data LM-79-08 & LM-80-08

*2200K not available for SO+ or HO.

ELECTRICAL

Input Voltage	100-277V AC 50Hz/60Hz
Control	Electronic Low Voltage Reverse Phase Trailing Edge
Power Factor	≥ 0.98

MAX CONTINUOUS RUN

	120V AC	277V AC
LO	180ft	360ft
SO	120ft	240ft
SO+	60ft	120ft
HO	60ft	120ft
HO+	60ft	120ft

MODA TECHNOLOGY

moda SOFTWARE [™]	moda ZERO BIN [™]
moda HARDWARE [™]	moda THERMAL MANAGEMENT [™]
moda PHOSPHOR [™]	moda AIRFLOW [™]
moda HIGH CRI [™]	moda COMMUNICATE [™]
moda DRIVER [™]	moda KWIK CONNECT [™]

STANDARDS & CERTIFICATIONS



Certification Tested to UL & CSA by Intertek For Use in USA & CANADA. Exceeds ANSI C78.377-2015, CE, CCC, C-Tick, RoHS, & WEEE Compliant. Meets ASHRAE standards.

Class	1
Warranty	5 Year Limited Warranty

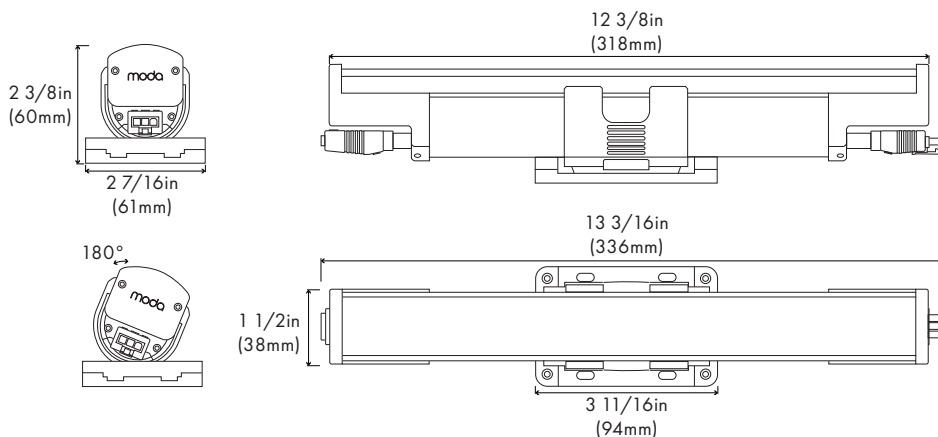

ELV

1FT	6°		10°		25°		40°		10°x40°		30°x60°		Forward Throw Asymmetric		
Output	CCT	Lumens	Efficacy	Lumens	Efficacy	Lumens	Efficacy	Lumens	Efficacy	Lumens	Efficacy	Lumens	Efficacy	Lumens	Efficacy
SO+	2700K	751.60	75.16	942.30	94.23	928.20	92.82	827.08	82.71	1012.70	101.27	910.60	91.06	1020.68	102.07
	3000K	753.60	75.36	944.30	94.43	930.20	93.02	829.05	82.91	1014.30	101.43	913.00	91.30	1022.65	102.27
	3500K	756.60	75.66	947.30	94.73	933.20	93.32	832.05	83.21	1017.60	101.76	915.50	91.55	1025.65	102.57
	4000K	762.70	76.27	953.40	95.34	957.60	95.76	838.05	83.81	1026.30	102.63	921.50	92.15	1031.65	103.17
HO	2700K	1190.26	119.02	1195.30	119.53	1178.90	117.89	1077.26	107.73	1631.70	163.17	1160.10	116.01	1270.86	127.09
	3000K	1320.36	132.03	1316.80	131.68	1298.80	129.88	1197.05	119.71	1784.80	178.48	1279.90	127.99	1390.96	139.10
	3500K	1358.10	135.81	1365.10	136.51	1335.20	133.52	1245.10	124.51	1845.60	184.56	1327.50	132.75	1438.70	143.87
	4000K	1407.15	140.71	1414.70	141.47	1394.10	139.41	1294.15	129.42	1497.35	149.74	1376.50	137.65	1489.75	148.98

*2200K not available for SO+ or HO

1FT	30°x100°			30°x100°			30°x100°				
Output	CCT	Lumens	Efficacy	Output	CCT	Lumens	Efficacy	Output	CCT	Lumens	Efficacy
LO	2200K	225.30	22.53	SO	2200K	305.82	30.58	HO+	2200K	976.10	97.61
	2700K	278.80	27.90		2700K	405.60	40.56		2700K	1097.10	109.71
	3000K	289.6	28.96		3000K	441.23	44.12		3000K	1100.50	110.5
	3500K	309.4	30.94		3500K	442.20	44.22		3500K	1111.80	111.18
4000K	316.6	31.66	4000K	444.45	44.45	4000K	1115.30	111.53			

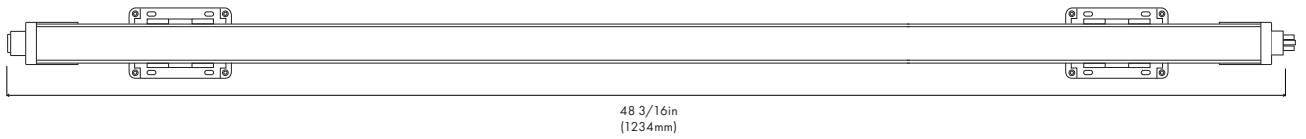
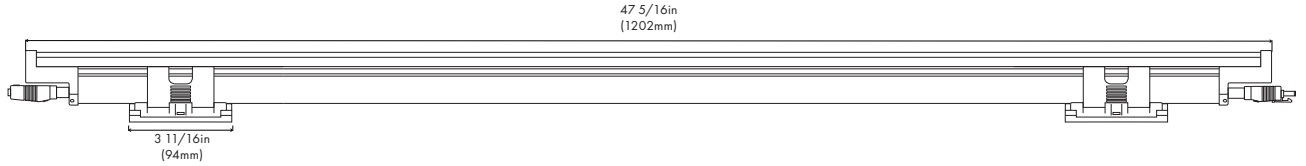
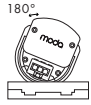
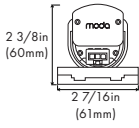

ELV

4FT	6°		10°		25°		40°		10°x40°		30°x60°		Forward Throw Asymmetric		
Output	CCT	Lumens	Efficacy	Lumens	Efficacy	Lumens	Efficacy	Lumens	Efficacy	Lumens	Efficacy	Lumens	Efficacy	Lumens	Efficacy
SO+	2700K	2551.50	63.79	3350.80	83.77	3292.90	82.32	3274.68	81.86	3765.10	94.13	3275.20	81.88	3391.28	84.78
	3000K	2559.20	63.98	3358.40	83.96	3300.40	82.51	3282.23	82.05	3772.70	94.32	3282.70	82.07	3422.83	85.57
	3500K	2576.40	64.41	3387.80	84.70	3317.30	82.93	3299.10	82.48	3789.90	94.75	3299.60	82.49	3415.80	85.40
	4000K	2599.8	64.41	3399.00	84.98	3340.50	83.51	3322.40	83.06	3813.40	95.34	3322.80	83.07	3439.00	85.98
HO	2700K	3566.50	89.16	4365.50	109.14	4293.70	107.73	4278.02	106.95	4744.80	118.62	4276.00	106.90	4394.60	109.87
	3000K	4043.40	101.09	4843.30	121.08	4768.50	119.21	4749.40	118.73	5212.30	130.31	4746.20	118.65	4866.00	121.65
	3500K	4242.70	106.07	5027.30	125.68	4960.40	124.01	4946.40	123.66	5411.70	135.30	4942.70	123.57	5063.00	126.58
	4000K	4425.00	110.63	5223.80	130.60	6137.60	153.44	5126.60	128.16	5594.10	139.85	5122.40	128.06	5243.20	131.08

*2200K not available for SO+ or HO

4FT	30°x100°			30°x100°			30°x100°				
Output	CCT	Lumens	Efficacy	Output	CCT	Lumens	Efficacy	Output	CCT	Lumens	Efficacy
LO	2200K	901.2	22.55	SO	2200K	1230.50	30.78	HO+	2200K	3868.30	96.71
	2700K	1109.90	27.75		2700K	1563.30	39.11		2700K	4126.60	103.17
	3000K	1298.20	32.46		3000K	1800.90	45.02		3000K	4743.40	118.59
	3500K	1228.60	30.72		3500K	1709.30	42.76		3500K	4357.50	108.94
4000K	1264.60	31.62	4000K	1768.30	44.24	4000K	4461.30	111.53			

6° Beam Angle

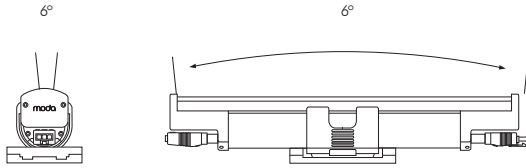

Polar Candela Distribution (HO 4000K)

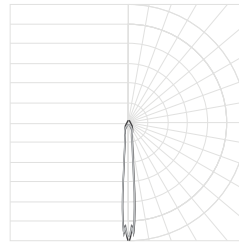

Illuminance at a Distance (HO 4000K)

	Center Beam FC		Beam Width	
	1 Foot	4 Foot		
2.0 ft	41.43 fc	152.02 fc	0.4 ft	0.3 ft
4.0 ft	10.35 fc	38.00 fc	0.8 ft	0.7 ft
6.0 ft	5.17 fc	19.00 fc	1.2 ft	1.1 ft
8.0 ft	2.58 fc	9.50 fc	1.6 ft	1.5 ft
10.0 ft	1.29 fc	4.75 fc	2.1 ft	2.0 ft
12.0 ft	1.03 fc	3.80 fc	2.5 ft	2.4 ft

▲ Vert. Spread: 6° ▲ Horiz. Spread: 6°

10° Beam Angle

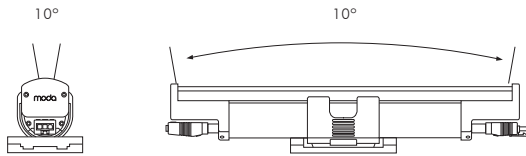

Polar Candela Distribution (HO 4000K)

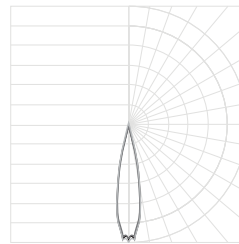

Illuminance at a Distance (HO 4000K)

	Center Beam FC		Beam Width	
	1 Foot	4 Foot		
2.0 ft	60.76 fc	224.32 fc	0.4 ft	0.3 ft
4.0 ft	15.19 fc	56.08 fc	0.8 ft	0.7 ft
6.0 ft	7.59 fc	28.04 fc	1.2 ft	1.1 ft
8.0 ft	3.79 fc	14.02 fc	1.6 ft	1.5 ft
10.0 ft	1.89 fc	7.01 fc	2.1 ft	2.0 ft
12.0 ft	1.51 fc	5.60 fc	2.5 ft	2.4 ft

▲ Vert. Spread: 10° ▲ Horiz. Spread: 10°

25° Beam Angle

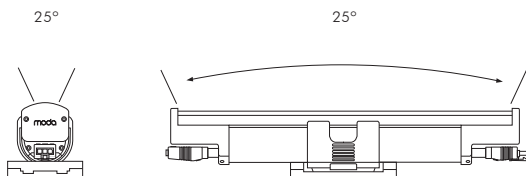

Polar Candela Distribution (HO 4000K)

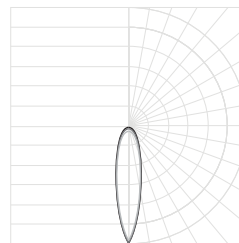

Illuminance at a Distance (HO 4000K)

	Center Beam FC		Beam Width	
	1 Foot	4 Foot		
2.0 ft	37.34 fc	224.32 fc	0.5 ft	0.5 ft
4.0 ft	9.33 fc	56.08 fc	1.0 ft	1.0 ft
6.0 ft	4.66 fc	28.04 fc	1.5 ft	1.6 ft
8.0 ft	2.33 fc	14.02 fc	2.0 ft	2.2 ft
10.0 ft	1.16 fc	7.01 fc	2.5 ft	2.7 ft
12.0 ft	0.93 fc	5.60 fc	3.0 ft	3.2 ft

▲ Vert. Spread: 25° ▲ Horiz. Spread: 25°

40° Beam Angle

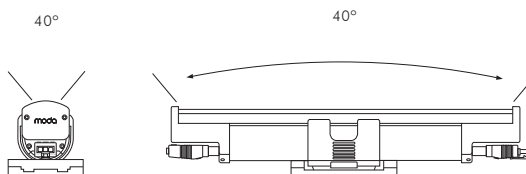

Polar Candela Distribution (HO 4000K)

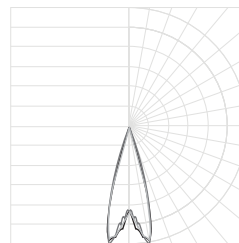

Illuminance at a Distance (HO 4000K)

	Center Beam FC		Beam Width	
	1 Foot	4 Foot		
2.0 ft	17.07 fc	63.84 fc	1.0 ft	0.8 ft
4.0 ft	4.26 fc	15.96 fc	1.9 ft	1.5 ft
6.0 ft	2.13 fc	7.98 fc	2.8 ft	2.4 ft
8.0 ft	1.06 fc	3.99 fc	3.8 ft	3.2 ft
10.0 ft	0.53 fc	2.00 fc	4.8 ft	4.0 ft
12.0 ft	0.42 fc	1.60 fc	5.7 ft	4.7 ft

▲ Vert. Spread: 40° ▲ Horiz. Spread: 40°

10°x40° Beam Angle

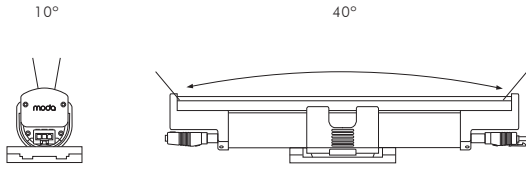

Polar Candela Distribution
(HO 4000K)

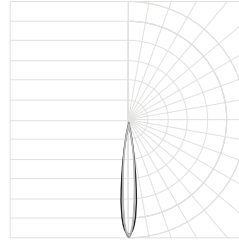

Illuminance at a Distance (HO 4000K)

	Center Beam FC		Beam Width	
	1 Foot	4 Foot		
2.0 ft	42.72 fc	160.52 fc	0.7 ft	0.5 ft
4.0 ft	10.68 fc	40.13 fc	1.5 ft	1.0 ft
6.0 ft	5.34 fc	20.06 fc	2.2 ft	1.4 ft
8.0 ft	2.67 fc	10.03 fc	3.0 ft	1.9 ft
10.0 ft	1.33 fc	5.01 fc	4.6 ft	2.4 ft
12.0 ft	1.06 fc	4.01 fc	4.4 ft	3.0 ft

▲ Vert. Spread: 10° ▲ Horiz. Spread: 40°

30°x60° Beam Angle

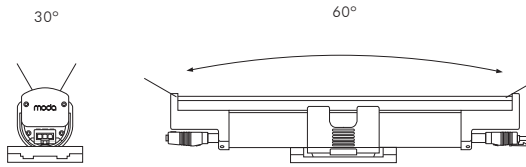

Polar Candela Distribution
(HO 4000K)

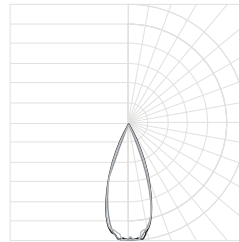

Illuminance at a Distance (HO 4000K)

	Center Beam FC		Beam Width	
	1 Foot	4 Foot		
2.0 ft	108.73 fc	409.17 fc	1.3 ft	2.0 ft
4.0 ft	27.18 fc	102.29 fc	3.1 ft	4.7 ft
6.0 ft	13.59 fc	51.15 fc	4.0 ft	6.6 ft
8.0 ft	6.79 fc	25.15 fc	5.8 ft	9.3 ft
10.0 ft	3.39 fc	12.79 fc	7.0 ft	11.2 ft
12.0 ft	2.71 fc	10.23 fc	9.0 ft	14.0 ft

▲ Vert. Spread: 30° ▲ Horiz. Spread: 60°

Forward Throw Asymmetric Beam Angle

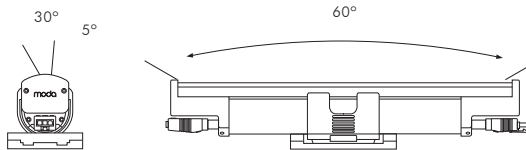

Polar Candela Distribution
(HO 4000K)

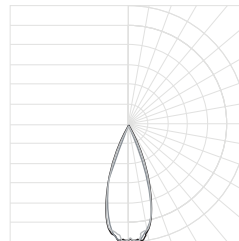

Illuminance at a Distance (HO 4000K)

	Center Beam FC		Beam Width	
	1 Foot	4 Foot		
2.0 ft	37.34 fc	59.40 fc	0.5 ft	0.5 ft
4.0 ft	9.33 fc	14.85 fc	1.0 ft	1.0 ft
6.0 ft	4.66 fc	7.42 fc	1.5 ft	1.6 ft
8.0 ft	2.33 fc	3.71 fc	2.0 ft	2.2 ft
10.0 ft	1.16 fc	1.85 fc	2.5 ft	2.7 ft
12.0 ft	0.93 fc	1.48 fc	3.0 ft	3.2 ft

▲ Vert. Spread: 30° ▲ Horiz. Spread: 60°

30°x100° Beam Angle

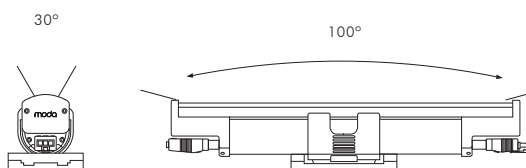

Polar Candela Distribution
(HO+ 4000K)

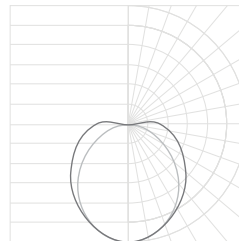

Illuminance at a Distance (HO+ 4000K)

	Center Beam FC		Beam Width	
	1 Foot	4 Foot		
2.0 ft	114.8 fc	459.20 fc	1.3 ft	2.0 ft
4.0 ft	28.7 fc	114.80 fc	3.1 ft	4.2 ft
6.0 ft	14.3 fc	57.40 fc	4.0 ft	6.6 ft
8.0 ft	7.1 fc	28.7 fc	5.8 ft	9.3 ft
10.0 ft	3.5 fc	14.30 fc	7.0 ft	11.2 ft
12.0 ft	2.8 fc	11.40 fc	9.0 ft	14.0 ft

▲ Vert. Spread: 30° ▲ Horiz. Spread: 100°

2200K TM30

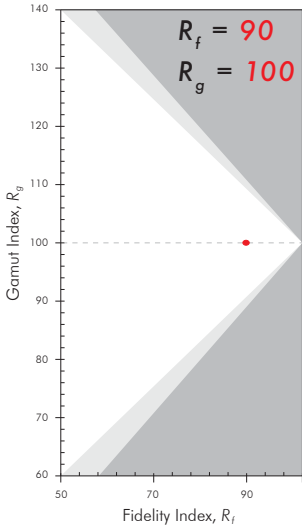

Color Evaluation Sample

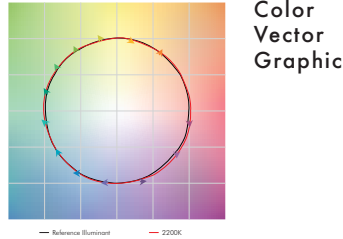
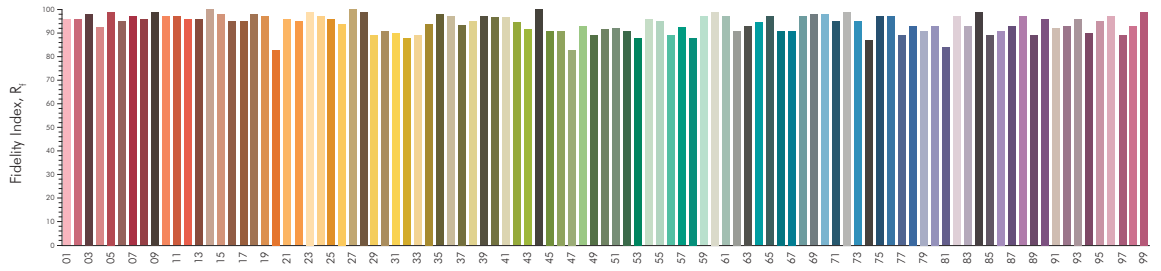

2700K TM30

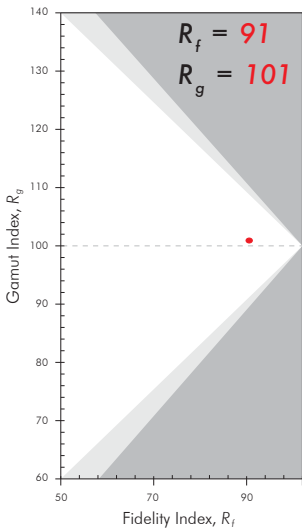

Color Evaluation Sample

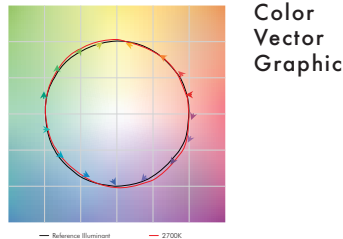
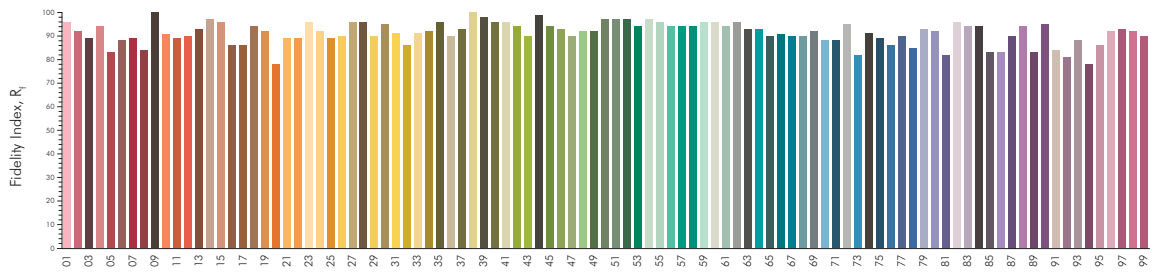

3000K TM30

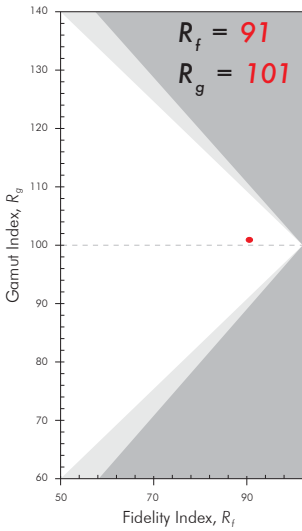

Color Evaluation Sample

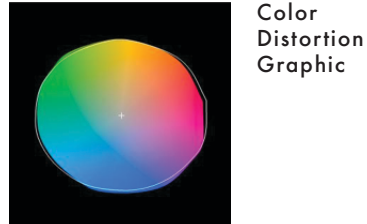
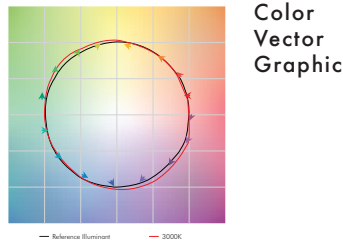
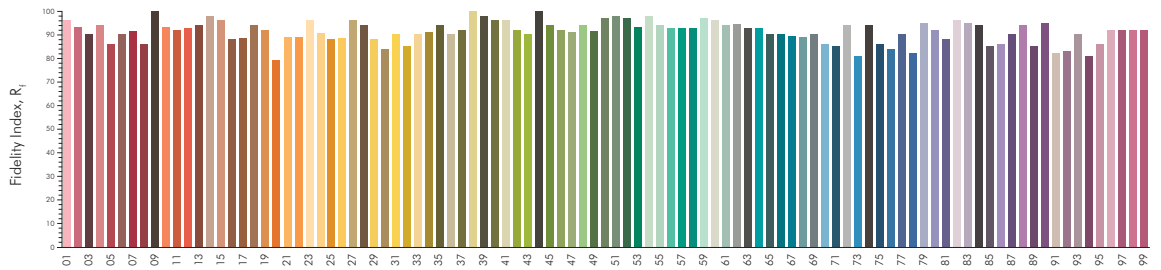

3500K TM30

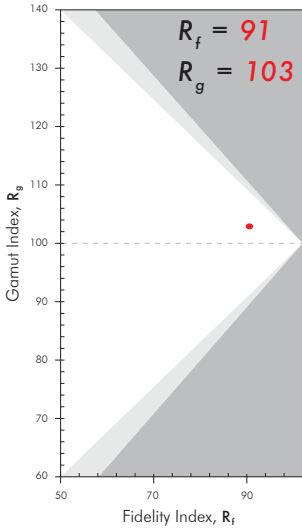

Color Evaluation Sample

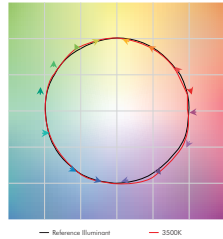
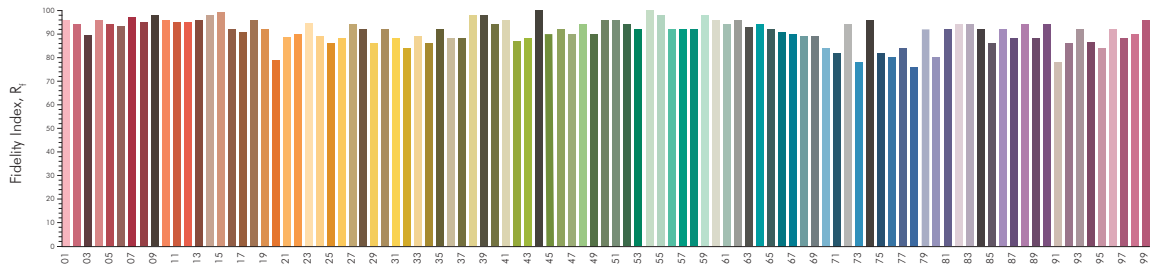

Color Vector Graphic



Color Distortion Graphic

4000K TM30

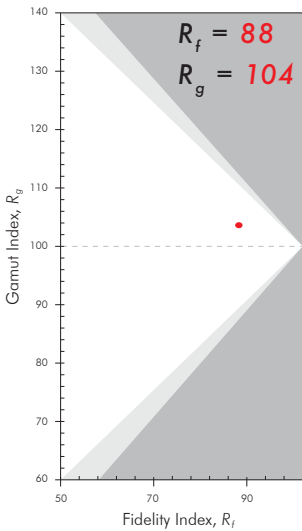

Color Evaluation Sample

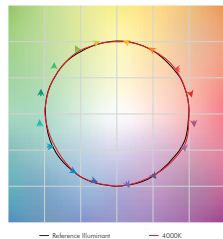
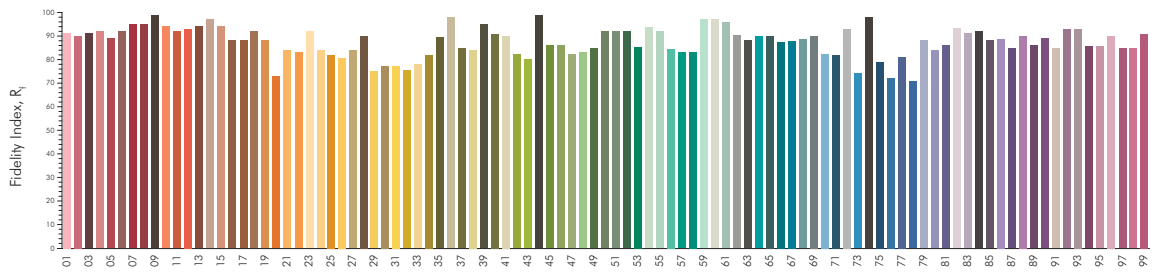

Color Vector Graphic



Color Distortion Graphic

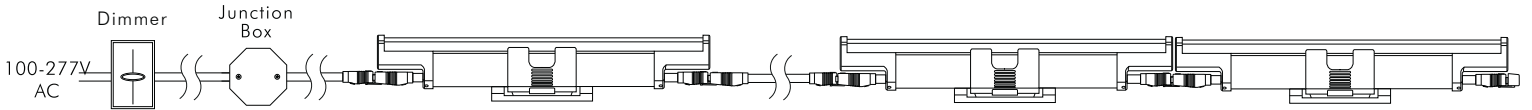

UL / cUL Non-dimming

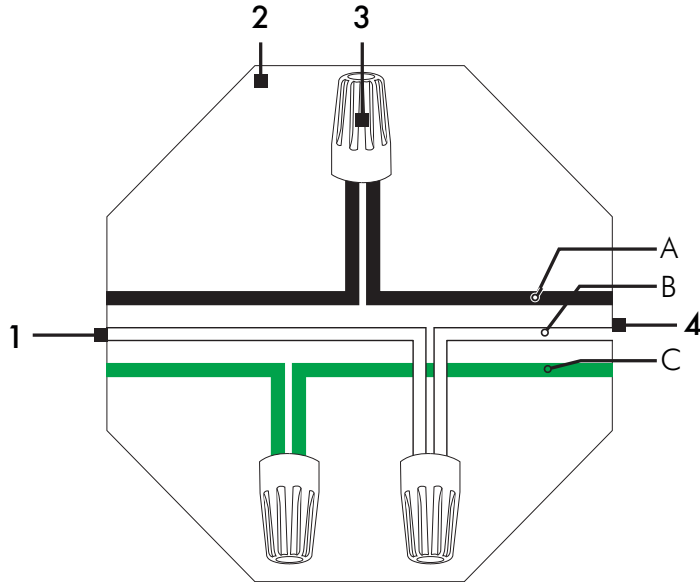

UL / cUL ELV Dimming

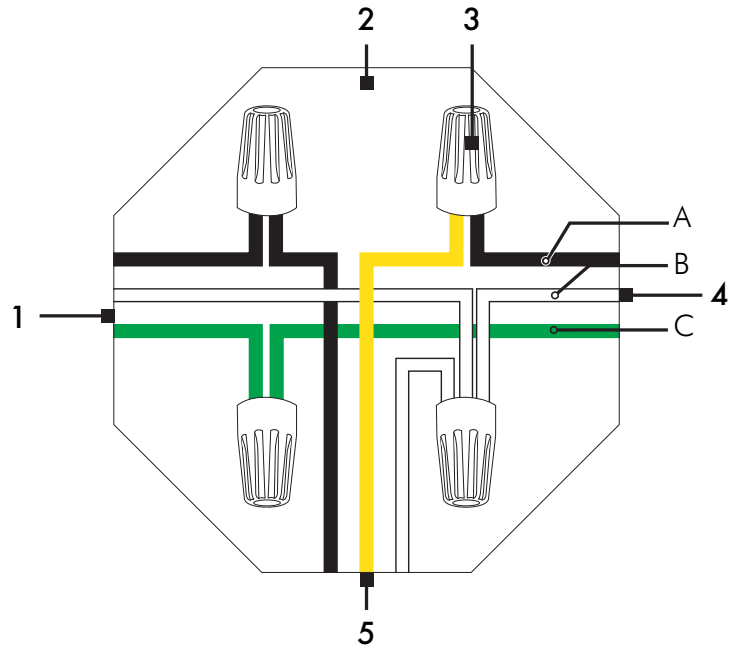

Wiring Legend

1	Power 100-277V AC
2	Junction Box
3	Wiring Nuts
4	3 Pin Leader Cable
5	ELV Dimmer

3 Pin Leader Cable

UL/cUL	
A Live 100-277V AC	— Black
B Neutral	— White
C Ground	— Green

ELV Connectors

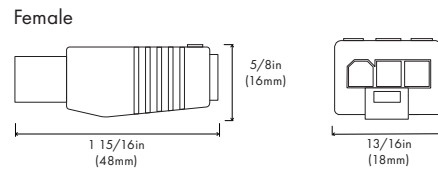
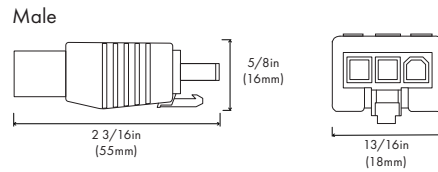

Angle Adjustment

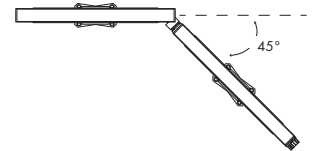

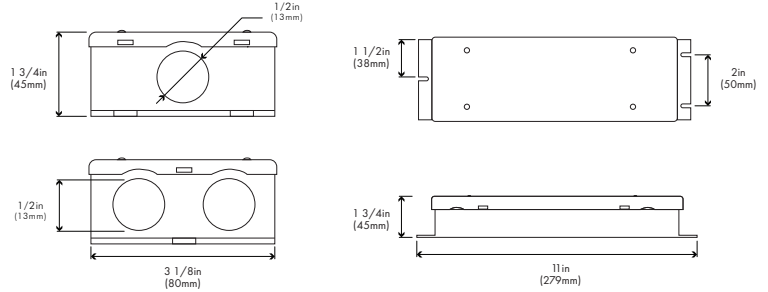

MODA BRIDGE 1

Converting 0-10V to ELV.

MODA BRIDGE 1 solves many installation issues. It accepts a standard 0-10V signal from most dimmers and dimming systems and internally converts this signal into a Electronic Low Voltage (ELV) signal. Thus enabling 0-10V control of an ELV fixture. It is optimized to perform precise smooth flicker free dimming down to 0%. Simple wiring with its integral 1/2in holes which accepts liquid tight or interior conduit connectors. Wire to any 100-277V 50/60 Hz feed. Power up to 840W of fixtures at 120V, 1600W at 230V, and 1900W at 277V. Fully potted enables the installer to mount this product virtually anywhere with its Wet Location IP65 rating. Fully protected from surge, short circuit, open circuit and over temperature. Power Input and data interface protected with High Grade Surge Protection. Designed and developed by MODA LIGHT, Las Vegas USA

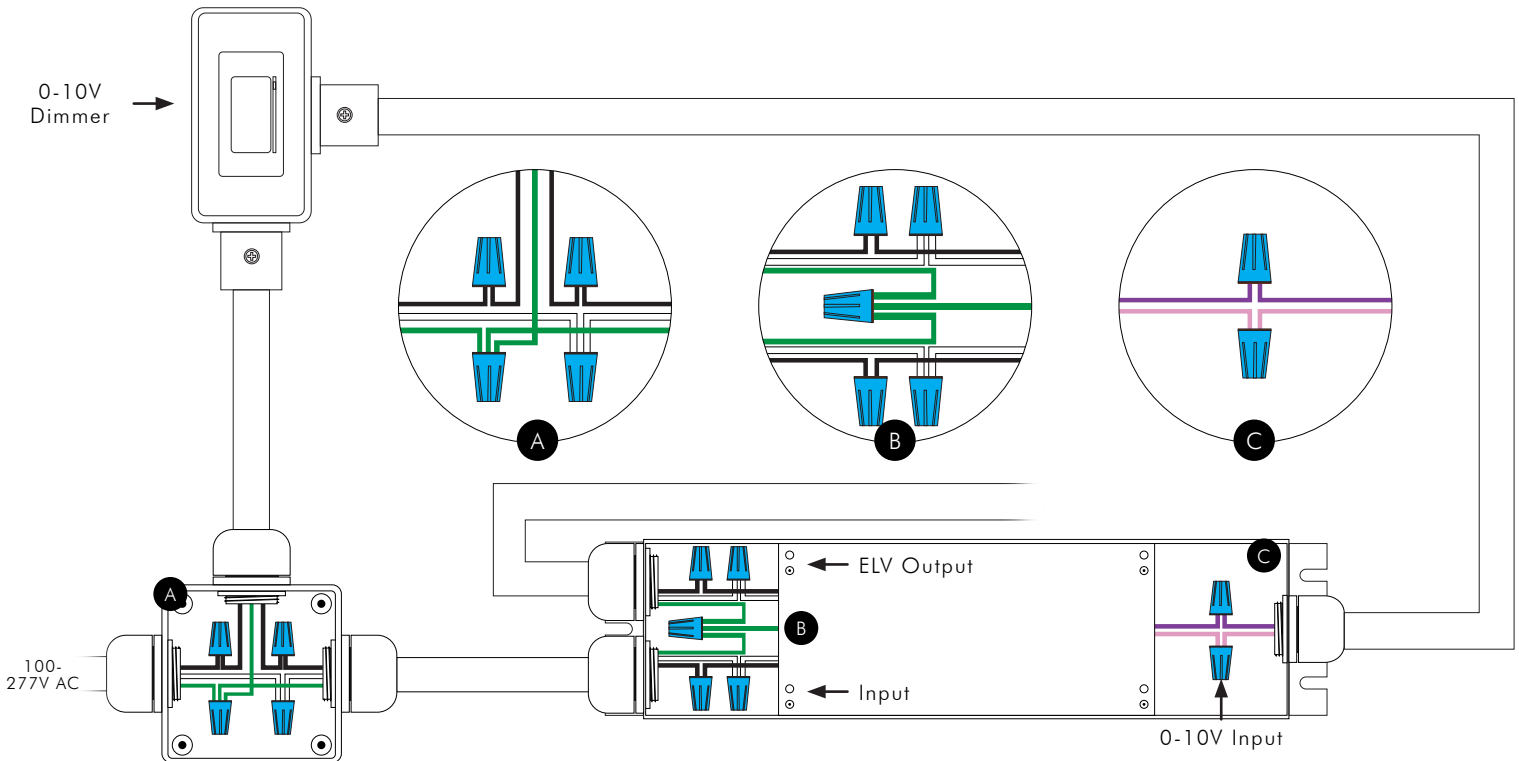

Input

	UL/cUL	
Live 100-277V AC	—	Black
Neutral	—	White
Ground	—	Green
0-10V / Data +	—	Purple
0-10V / Data -	—	Pink

Output

	UL/cUL	
Live 100-277V AC	—	Black
Neutral	—	White
Ground	—	Green

ELV Leader Cables

Moda Cove Interior 3 Pin Leader Cables

	UL/cUL
Lengths	10ft and 25ft
Color	Gray

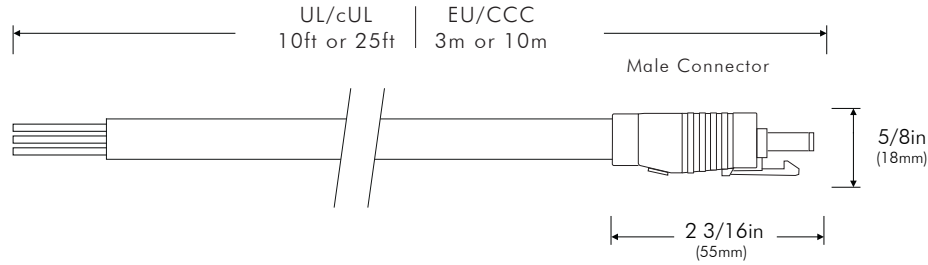

Connectors

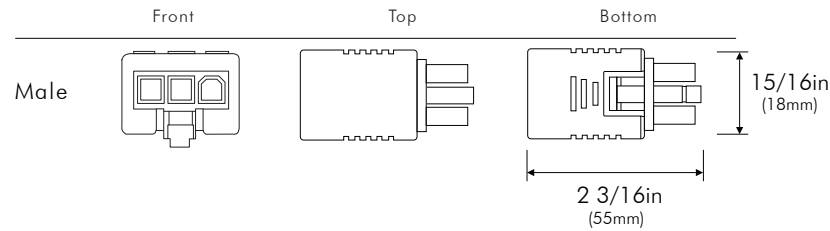

ELV Jumper Cables

Moda Cove Interior 3 Pin Jumper Cables

	UL/cUL
Lengths	1ft and 4ft
Color	Gray

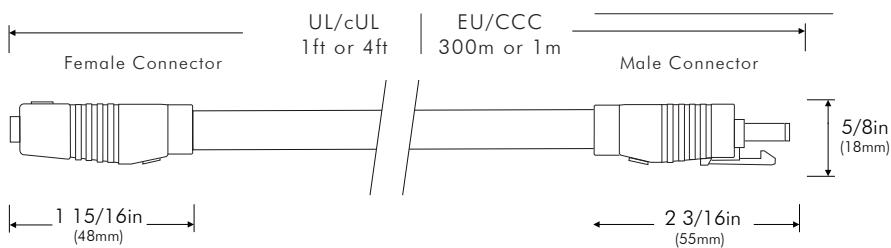

Connectors

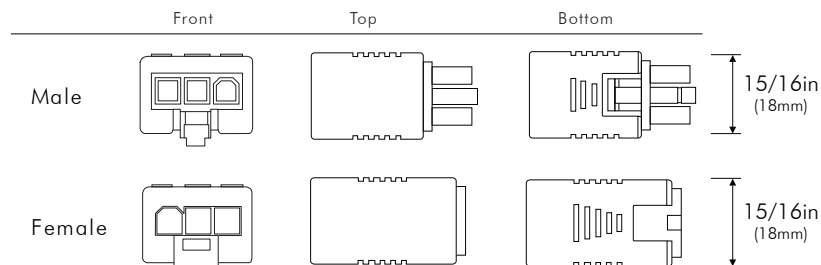

Pin Assignment

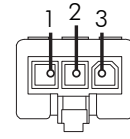

	UL/cUL
1 Live 100-277V	Black
2 Ground	Green
3 Neutral	White

Pin Assignment

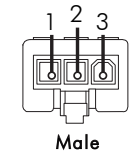

	UL/cUL
1 Live 100-277V	Black
2 Ground	Green
3 Neutral	White

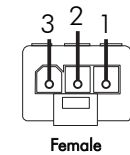

	UL/cUL
1 Live 100-277V	Black
2 Ground	Green
3 Neutral	White

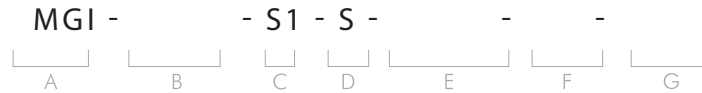

COMPLETE SKU SAMPLE: MGI-HO-S1-S-22H-1-6

A - FIXTURE & LOCATION

MGI — Moda Graze Interior

B - LIGHT OUTPUT

LO — Low Output
 SO — Standard Output
 SO+ — Standard Output Plus
 HO — High Output
 HO+ — High Output Plus

C - SERIES NUMBER

S1 — Series 1

D - PRODUCT FINISH

S — Silver

E - FIXTURE & LOCATION

22H* — 2200K
 27H — 2700K
 3H — 3000K
 35H — 3500K
 4H — 4000K

*Not available for SO+ and HO

F - LENGTH

1 — 1FT
 4 — 4FT

G - OPTIC

6* — 6° x 6°
 10* — 10° x 10°
 25* — 25° x 25°
 40* — 40° x 40°
 140* — 10° x 40°
 360* — 30° x 60°
 365* — Forward Throw Asymmetric
 310** — 30° x 100°

*Available only in SO+ and HO

**Available only in LO, SO and HO+

ACCESSORIES	DESCRIPTION	ORDERING SKU
Leader Cable US 3 Pin 10FT	Power to first fixture of run	MLCI-US-3PIN-G-10FT
Leader Cable US 3 Pin 25FT	Power to first fixture of run	MLCI-US-3PIN-G-25FT
Jumper Cable US 3 Pin 1FT	Connection between fixtures	MJCI-US-3PIN-G-1FT
Jumper Cable US 3 Pin 4FT	Connection between fixtures	MJCI-US-3PIN-G-4FT
Terminator 3 Pin	Must be fixed to last fixture for safety	MTI-3PIN-G
Interior Bracket Lock	Holds fixture in place for vertical installation	MCGI-BL-G

CONTROLS	DESCRIPTION	PART NUMBER	ORDERING SKU
MODA Bridge 1 2.0 US	Allows user to convert a 0-10V dimming signal into an ELV dimming signal. North American Model	MODA-BRIDGE-1-S2-S	250-0000