

RGB Wet Location LED Linear Flex System

RGB AQUAFLEX is a premium version of the AQUAFLEX family. This model provides the same stable consistent energy efficient qualities that characterise the AQUAFLEX family - only now it uses a 3 in 1 RGB LED. Compatible with DMX512 and capable of producing 16.7 million color variations. RGB AQUAFLEX is housed in a special grade silicone sleeve, field cuttable every 4in, and has available mounting clips and end caps for simple installation.

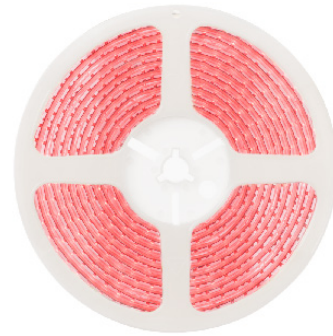

OUTPUT

Delivered Lumens	185 lm/ft
CCT & SDMC	N/A
Chromaticity Coordinates	x: 0.1964 y: 0.2251 u: 0.1480 v: 0.3816
Color Bin Tolerance	N/A
Efficacy (lm/W)	54.41
CRI	N/A
Lumen Maintenance	70,000 Hours L70 @ 25°C 90,000 Hours L50 @ 25°C 50,000 Hours L70 @ 50°C 70,000 Hours L50 @ 50°C
Testing Data	Light Data LM-79-08 & LM-80-08

ELECTRICAL

Input Voltage	24V DC
Power Consumption	3.40W per ft (0.02A)
Power Factor	≤ 1
Control	DMX512

CIE 1931 CHROMATICITY DIAGRAM

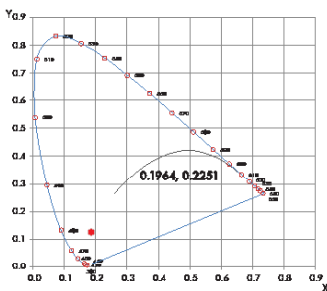

LUMINANCE DATA (cd/sq.m)

Angle in Degrees	Average 0-Deg	Average 45-Deg	Average 90-Deg
45	9493	6655	5939
55	9206	5749	4930
65	8152	4276	3630
75	5432	2311	1921
85	3337	917	734

PHYSICAL

Applications	IP67 Wet Locations, Cabinet, Cove, Display, Niches, Perimeter Lighting
Dimensions	Length 157 1/2in (4m) Width 1/2in (13mm) Height 11/64in (5mm)
LED Spacing	9/16in (14mm)
Beam Distribution	110°
Cutting Distance	4in (101mm)
Weight	11.2oz (317.5g) Per Reel
Construction	Constant Voltage Design Protects LEDs and Prolongs Life. White FPCB Inside a Silicone Sleeve
Thermal Management	N/A
Optics	N/A
Fixture Connections	Solder joints
Operating Temperature	-22°F ~ 122°F (-30°C ~ 50°C)
Storage Temperature	-40°F ~ 176°F (-40°C ~ 80°C)
Humidity	0-95% Non Condensing

DIMENSIONS

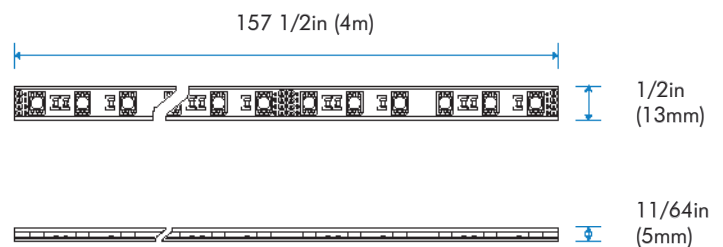

MODA TECHNOLOGY

modaPHOSPHOR™

modaZERO BIN™

STANDARDS & CERTIFICATIONS



LM
79

LM
80

3
YEAR
WARRANTY

Project Name:

Notes:

ILLUMINANCE AT A DISTANCE

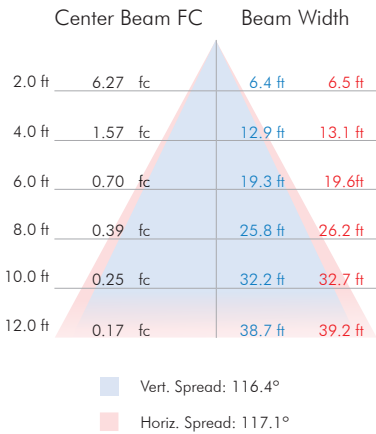

POLAR CANDELA DISTRIBUTION

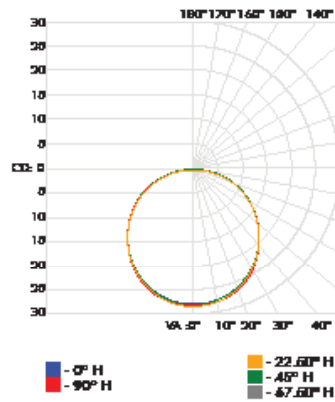

ZONAL LUMEN SUMMARY

Zone	Lumens	% Lamp	% Fixt
0-30	19.86	N.A.	25.50%
0-40	32.92	N.A.	42.30%
0-60	59.64	N.A.	76.60%
60-90	14.15	N.A.	18.20%
0-90	75.33	N.A.	96.70%
90-180	2.55	N.A.	3.30%
0-180	77.88	N.A.	100.00%

LUMENS PER ZONE

Zone	Lumens	% Lamp	% Fixt
0-10	2.38	N.A.	3.06%
10-20	6.88	N.A.	8.83%
20-30	10.59	N.A.	13.60%
30-40	13.07	N.A.	16.78%
40-50	13.92	N.A.	17.87%
50-60	12.80	N.A.	16.44%
60-70	9.45	N.A.	12.13%
70-80	4.70	N.A.	6.03%
80-90	1.54	N.A.	1.98%
90-100	0.86	N.A.	1.10%

WIRING

Connection in Series

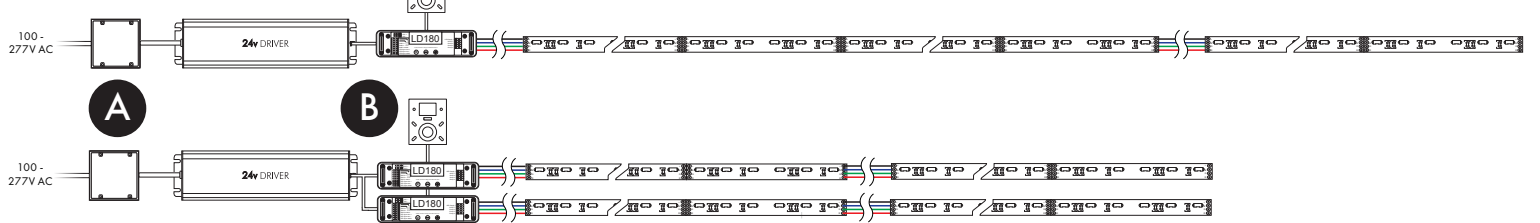

Connection in Parallel

Parallel Run DMX Wiring

Multiple connections in parallel can be made provided that each section does not exceed the Max Run Length of the product and does not exceed Max Load on driver.
 Example: 3 parallel connections x 156in lengths ≤ 39 total feet for Max Load determination.

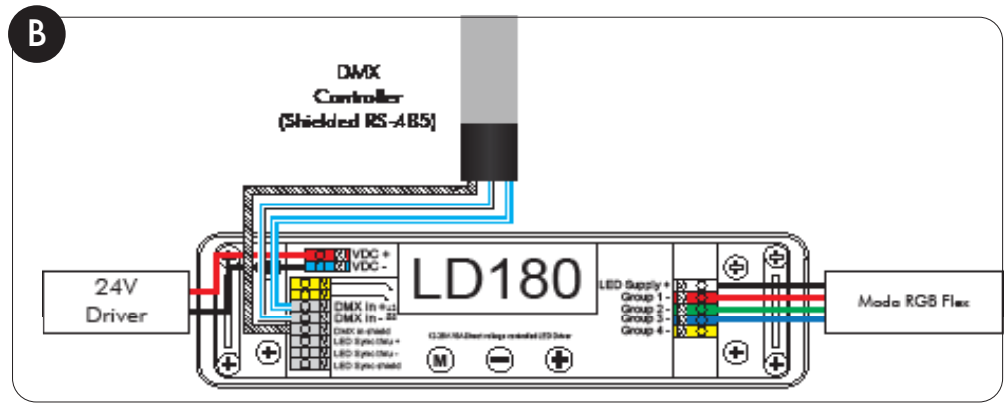
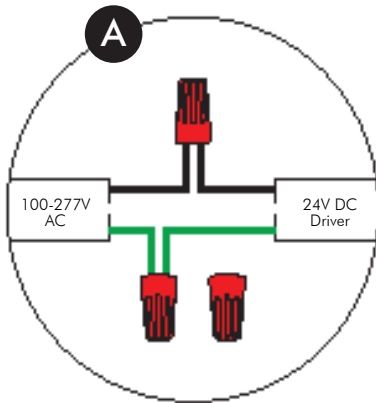

WIRING LEGEND

24V Driver Primary Side	24V Driver Secondary Side	DMX CONTROLLER	Leader Cable
— Live 100-277V AC	— DC Power Positive	— Data Positive	— 24V Positive
— Neutral AC	— DC Power Negative	— Data Negative	— Red
— Ground AC		— DMX Shield	— Green
			— Blue

MAX LOAD

150W Driver 39ft (11.9m)

MAX CONTINUOUS RUN

157 1/2in (4m)

FIXTURE	ORDERING SKU
Aquaflex RGB- IP67 Wet Location 13.12FT	RGB-AQF

POWER	ORDERING SKU
24V DC Driver - 100-277V AC Input - Non-Dimmable - 150W - IP20	MP17

ACCESSORIES	ORDERING SKU
Mounting Clip	MRTA61
End Cap	MRTA63
3M Super Silicone Sealant 3 oz	MRTA62
3M Super Silicone Sealant 1/10 Gal	MRTA62-XL

CONTROLS	DESCRIPTION	PART NUMBER	ORDERING SKU
Kandi Touch	DMX512 Wall Mounted Touch Panel Controller with Color Display	KND-TCH-B (Black)	250-0040
		KND-TCH-W (White)	250-0041
MODA Touch	DMX512 Wall Mounted Touch Panel Controller	MTCH-S1-B (Black)	MTCH-S1-B
		MTCH-S1-W (White)	MTCH-S1-W

CONTROL ACCESSORIES	DESCRIPTION	PART NUMBER	ORDERING SKU
Linear Drive 180	180W 4 Channel Constant Voltage DMX Interface	N/A	LD180
Shielded Cable 500FT	RS-485 Cable for DMX, 24 AWG stranded TC conductors, polyethylene insulation	SW-L-19827-1-500FT	250-0251
Shielded Cable 1000FT	RS-485 Cable for DMX, 24 AWG stranded TC conductors, polyethylene insulation	SW-L-19827-1-1000FT	250-0252