

SPECIFICATION

Dimmable LED Linear Flex System:

LINEARFLEX is a high quality polyepoxide flexible SSL solution. Integral IC's regulate power to each LED creating constant brightness and uniform life. Field cuttable at designated cutting points. Easy to install push to fit solderless range of wet location accessories completes a professional project. UV Protected. This product is sold by the meter, please consult factory. See MODA Metal® for extrusion options.



Dimensions:

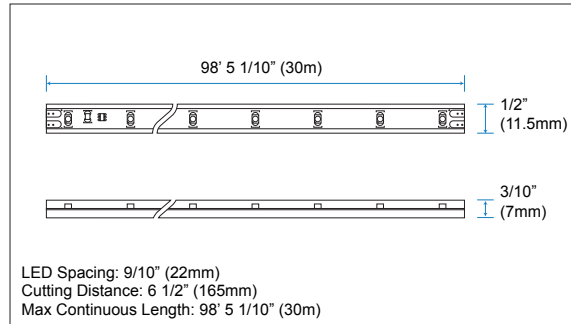

Output:

Delivered Lumens	8.03 lm / ft
CCT	N/A
Chromaticity Ordinates	x: 0.6938 y: 0.3060 u: 0.5251 v: 0.5212
Color Bin Tolerance	+ 3% / - 3%
Efficacy (lm/w)	7.50
Wavelength	627nm
Lumen Maintenance	70,000 Hours L70 @ 25°C : 90,000 Hours L50 @ 25°C 50,000 Hours L70 @ 50°C : 70,000 Hours L50 @ 50°C
Testing Data	Light Data LM-79-08 & LM-80-08

Illuminance at a Distance: Data Shown for 120°

(For lux multiply fc by 10.7)

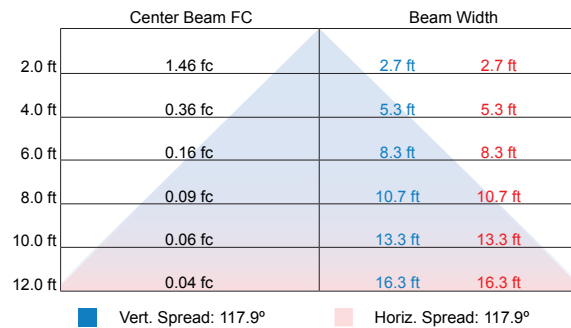

Electrical:

Input Voltage	24v DC
Power Consumption	1.07w / ft (0.04A) - Varies based on length of run & driver
Power Factor	≤ 1
Dimming	100-277v 0-10v & Magnetic Low Voltage
Emergency	N/A

Polar Candela Distribution:

Data Shown for 120°

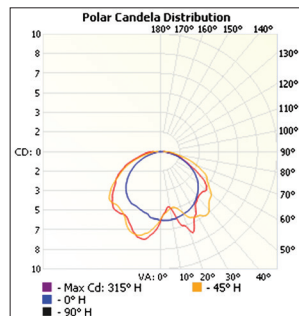

Lumens per Zone:

Zone	Lumens	% Total
0-10	0.19	2.40%
10-20	0.61	7.60%
20-30	1.01	12.60%
30-40	1.27	15.80%
40-50	1.43	17.80%
50-60	1.43	17.80%
60-70	1.14	14.20%
70-80	0.69	8.60%
80-90	0.26	3.20%
90-100	0.00	0.00%

Physical:

Applications	Wet Locations, Cabinet, Cove, Display, Niches, Perimeter Lighting
Dimensions	Length 98' 5 1/10" (30m) Width 1/2" (11.5mm) Height 3/10" (7mm)
Weight	7.3 lbs (3.31 Kg) Per Reel
Construction	Tough Polyepoxide UV Protected Body
Thermal Management	N/A
Optics	N/A
Fixture Connections	Push To Fit Connectors
Operating Temperature	-4°F ~ 113°F (-20°C ~ 45°C)
Storage Temperature	-4°F ~ 122°F (-20°C ~ 50°C)
Humidity	0-95% Non Condensing

Project Name:			
Notes:			

SPECIFICATION

Zonal Lumen Summary:

Zone	Lumens	% Lamp	% Fixt
0-30	1.81	N.A.	22.60%
0-40	3.08	N.A.	38.40%
0-60	5.93	N.A.	73.90%
60-90	1.83	N.A.	22.80%
0-90	8.03	N.A.	100%
90-180	0.00	N.A.	0.00%
0-180	8.03	N.A.	100%

Luminance Data (cd/sq.m):

Angle in Degrees	Average 0-Deg	Average 45-Deg	Average 90-Deg
45	933	587	527
55	834	502	446
65	701	366	317
75	452	198	172
85	361	96	83

CIE 1931 Chromaticity Diagram:

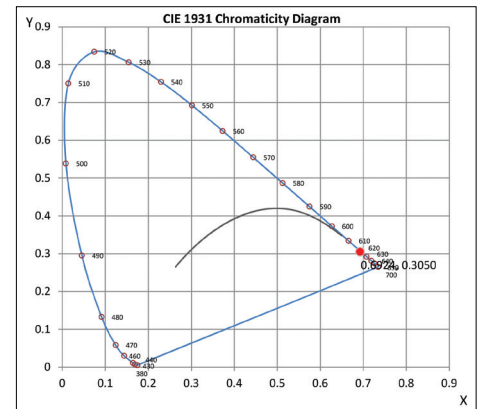

Spectral Power:

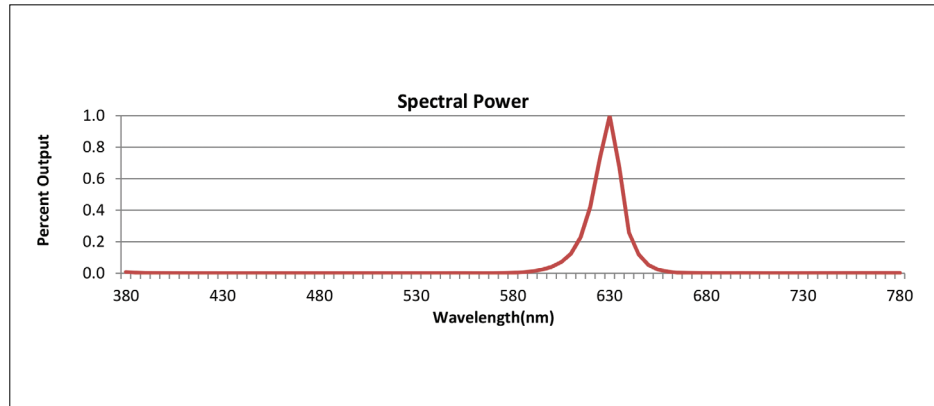

Polar Graph: Data Shown for 120°

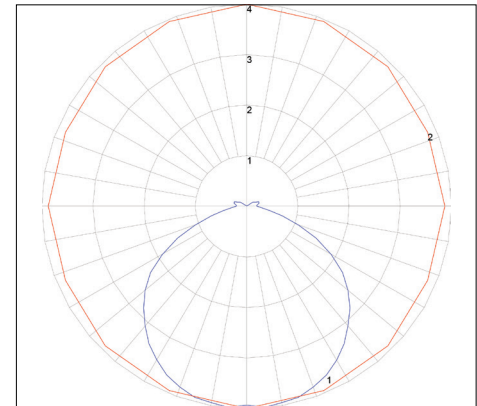

Accessories:

MRTA08 5' Leader Cable	MRTA06 Inline Connector for LINEARFLEX	MRTA07 1' Jumper Cable	MRTA04 Mounting Clips	MRTA02 End Cap	MRTA62 3oz 3M Marine Grade Super Silicone Sealant	MRTA62-XL 1/10 gal 3M Marine Grade Super Silicone Sealant
Connects LINEARFLEX to Power Supply	Connects Two LINEARFLEX Together	Connects Two LINEARFLEX And Allows for Flexible Corner Bends	Screws Into Surface To Hold LINEARFLEX	Terminates LINEARFLEX To Protect FPCB From Dust or Water	Applied Between LINEARFLEX, Connectors or End Caps to Seal From Exposure to Moisture	Applied Between LINEARFLEX, Connectors or End Caps to Seal From Exposure to Moisture
Connector Dim. L: 1 7/10" (44mm) W: 1 1/5" (30mm) H: 7/10" (19mm) Cable Dim. L: 5' (1.5m)	L: 1 7/10" (44mm) W: 1 1/5" (30mm) H: 7/10" (19mm)	Connector Dim. L: 1 7/10" (44mm) W: 1 1/5" (30mm) H: 7/10" (19mm) Cable Dim. L: 1' (330mm)	L: 1 1/10" (29mm) W: 3/10" (8mm) H: 3/10" (8mm) 2 Screws 7/10" (17mm)	L: 3/5" (16mm) W: 2/5" (10mm) H: 7/10" (18mm)		

Standards and Certifications:





Certification	Tested to UL & CSA by ETL For Use in USA & CANADA, Complies with California Title 24 Requirements, Lighting Facts. Exceeds ANSI C78.377A, CE & RoHS Compliant.
Class	Class 3
Environment	Wet Location - IP68
Warranty	5 Year Limited Warranty

Ordering:

SKU:	LINEARFLEX-RED
------	----------------

SPECIFICATION

Non Dimming		Voltage Range	Wattage	IP Rating	Dimension
MP17		100-277v AC	150w	IP67	8 7/10" x 2 7/10" x 1 1/2" (222mm x 68mm x 39mm)

0-10v Dimming		Voltage Range	Wattage	IP Rating	Dimension
MP06		347v AC	60w	IP66	9 2/5" x 1 7/10" x 1 3/10" (240mm x 43mm x 32mm)
MP19N		100-277v AC	60w	IP66	9 2/5" x 1 7/10" x 1 3/10" (240mm x 43mm x 32mm)
MP87		100-277v AC	100w	IP66	9 1/2" x 2 3/10" x 1 1/2" (241mm x 58mm x 37mm)
MP89		100-277v AC	150w	IP66	9 1/2" x 2 3/5" x 1 3/5" (241mm x 67mm x 40.5mm)

Ordering:

Sample SKU: MP19N